

PIPER SC

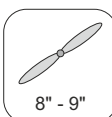

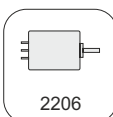

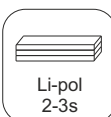

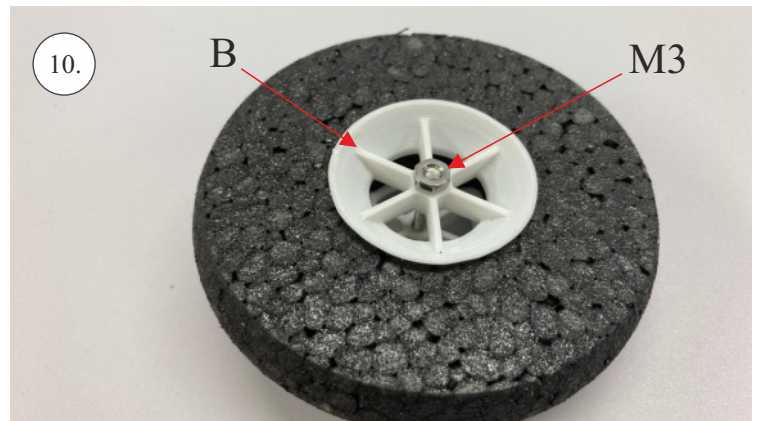
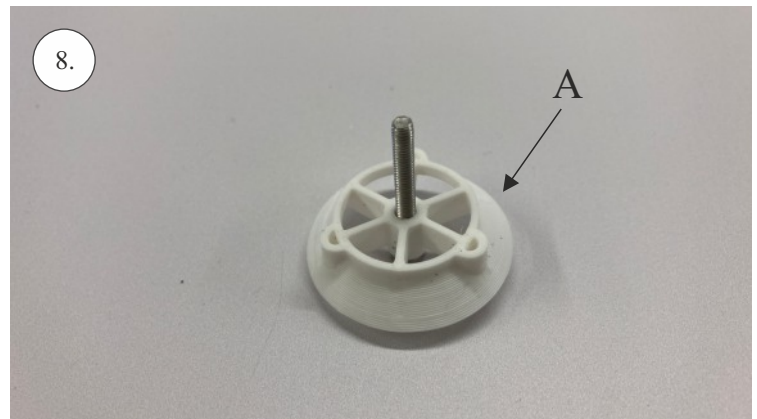
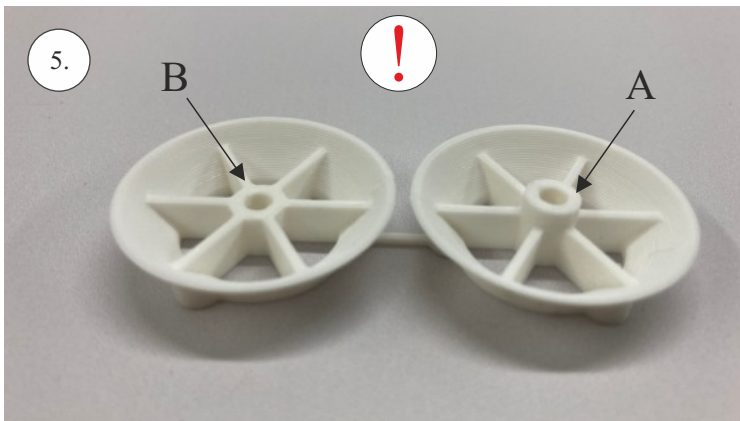
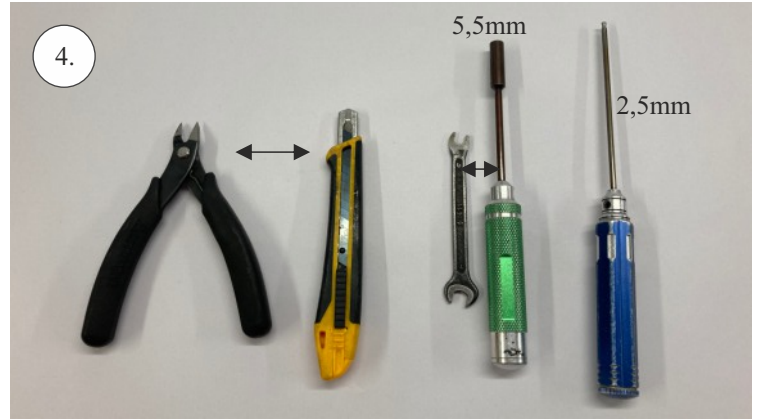
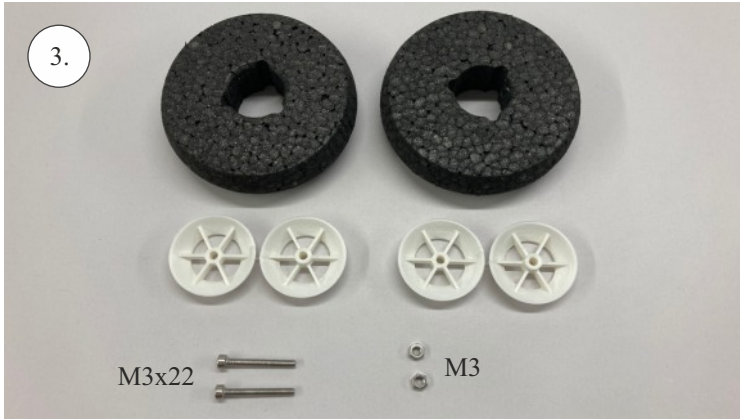
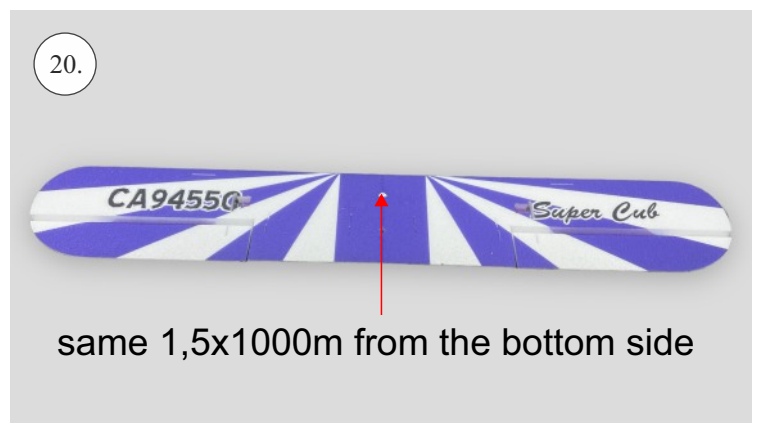
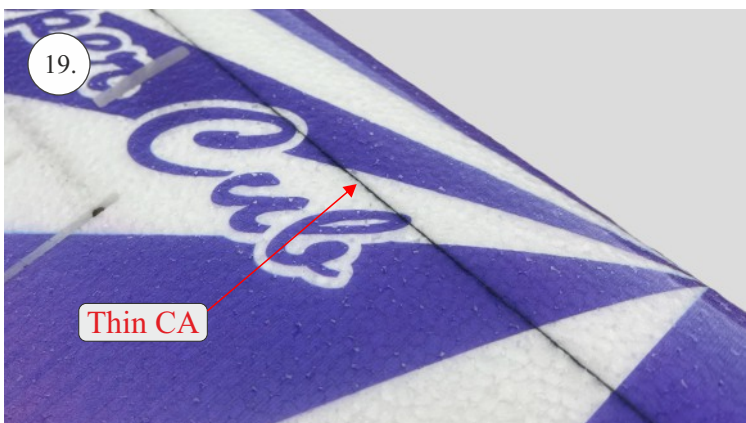
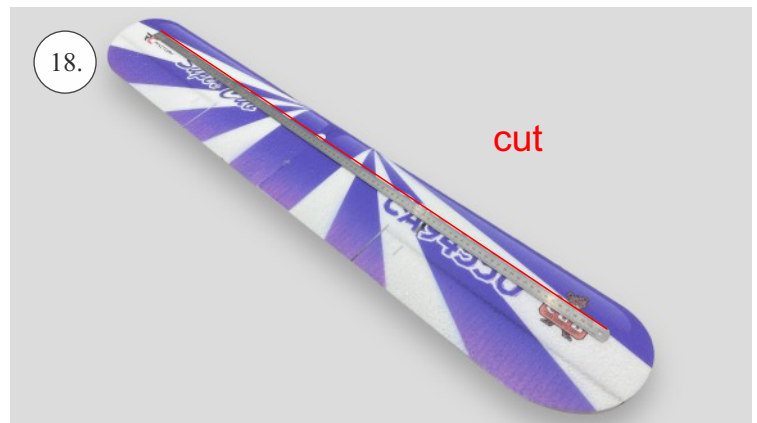
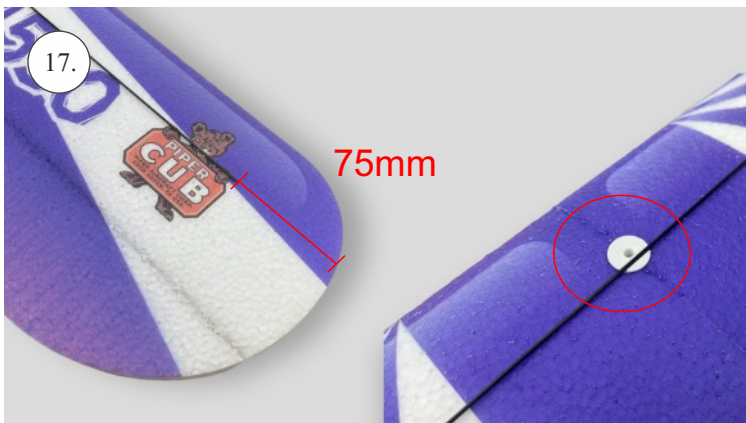
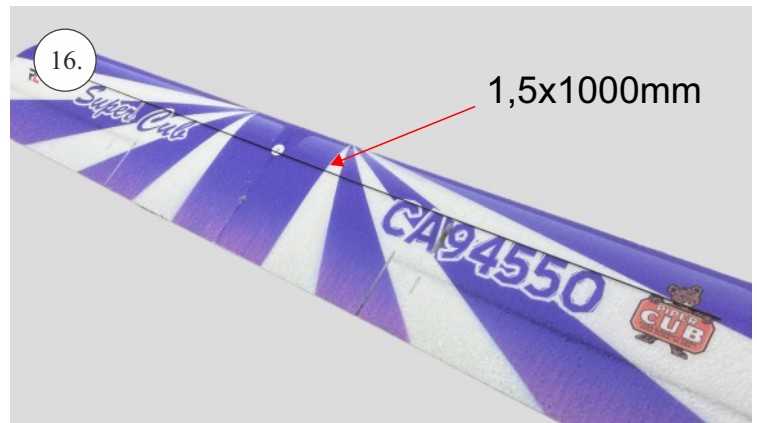
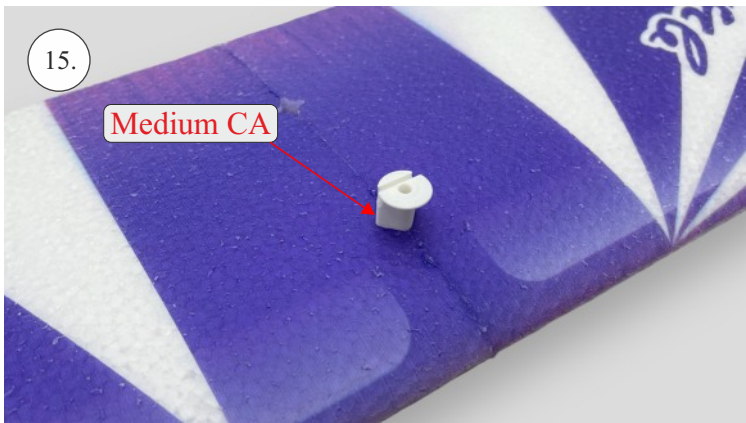
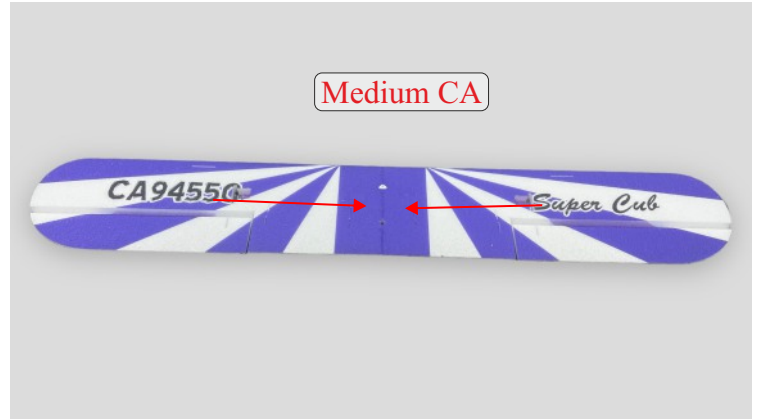
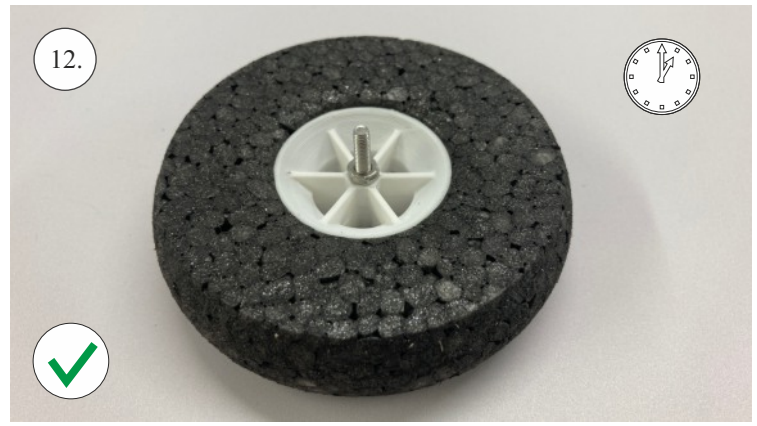
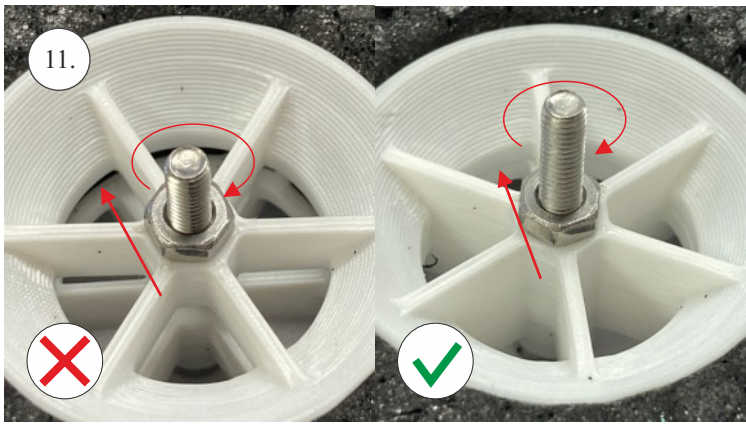
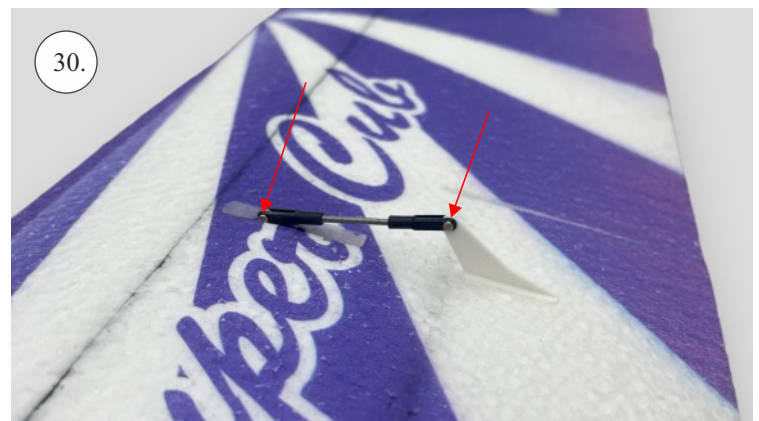
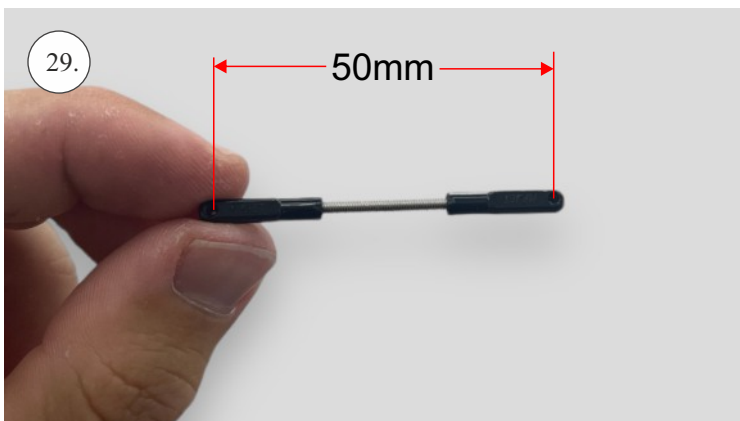
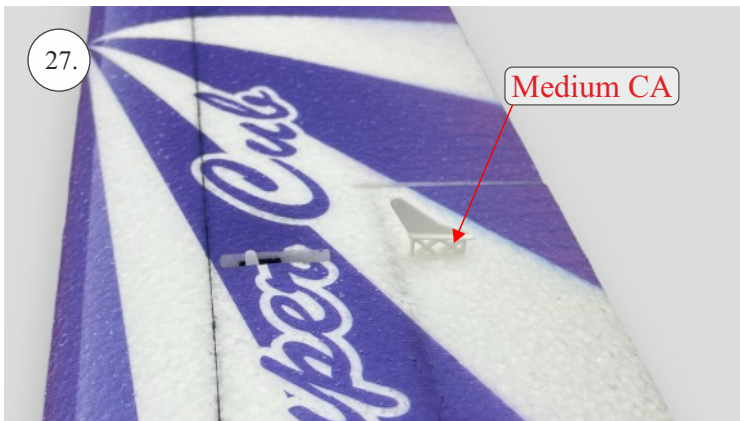
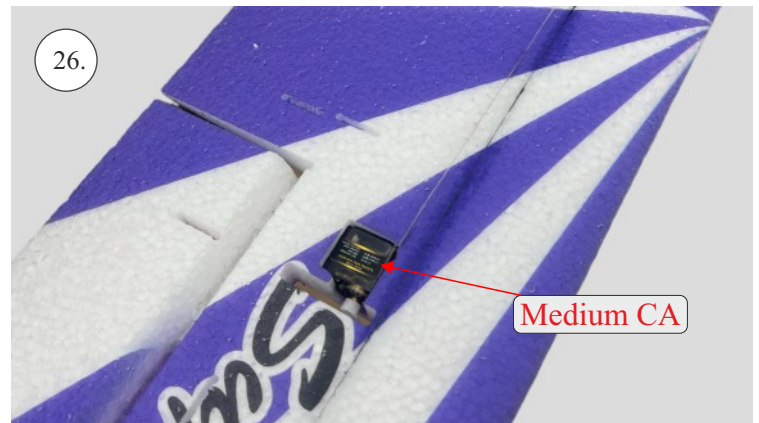
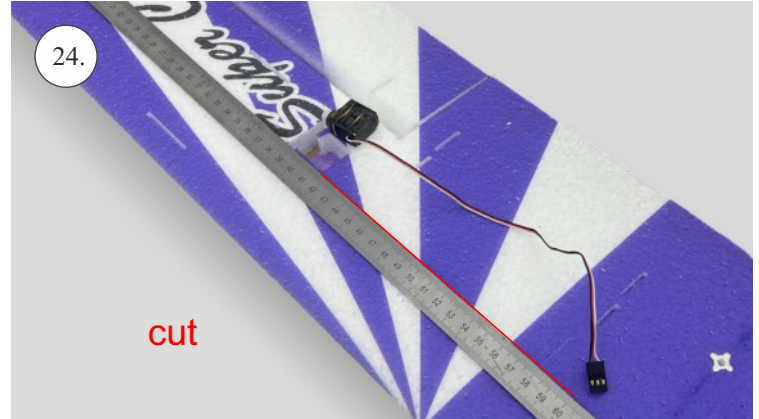
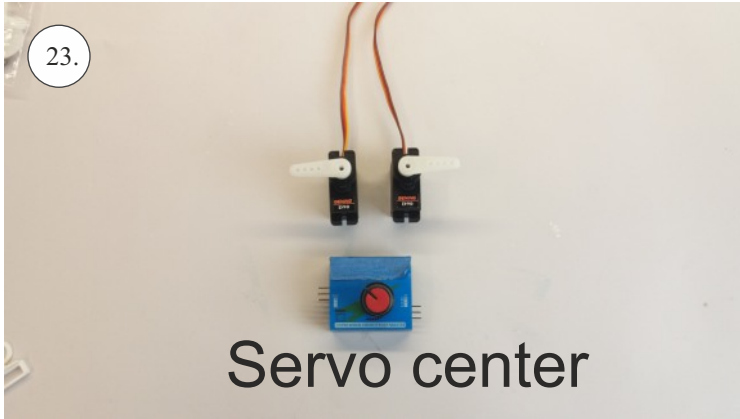
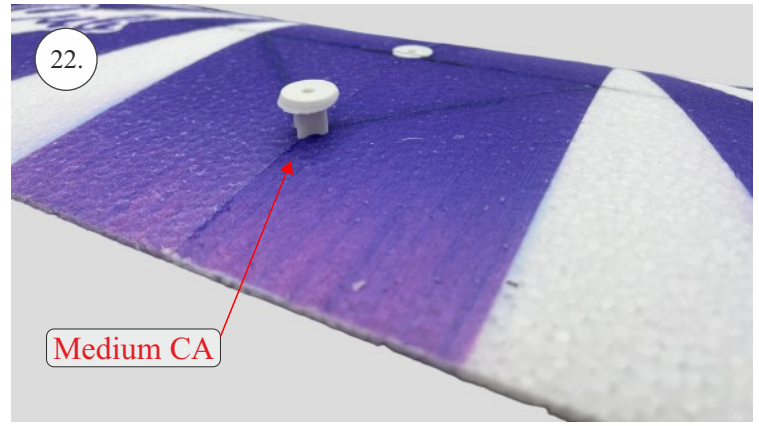
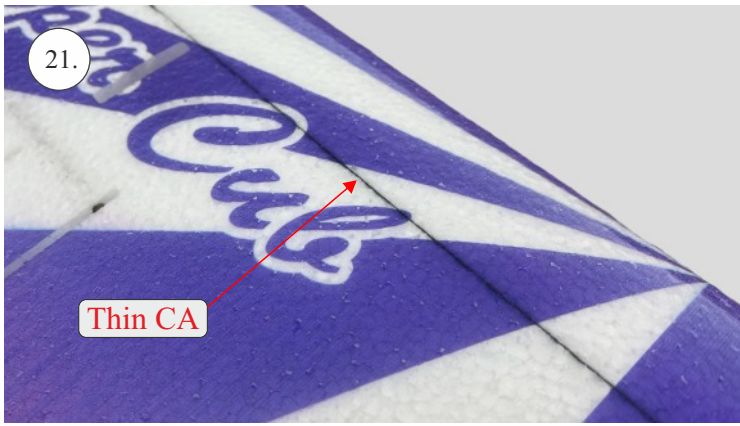

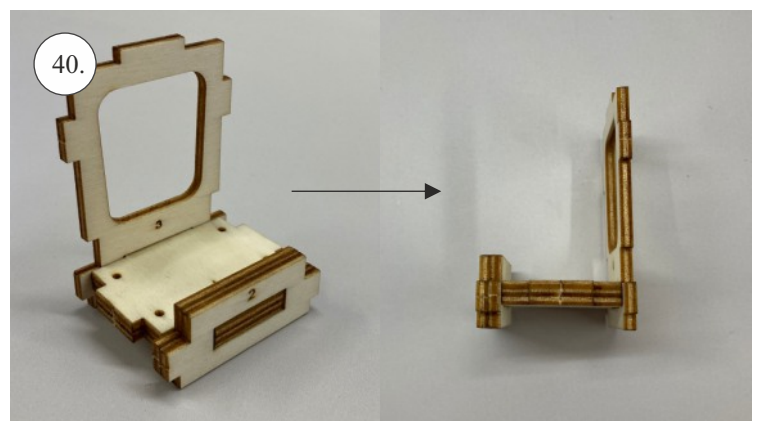
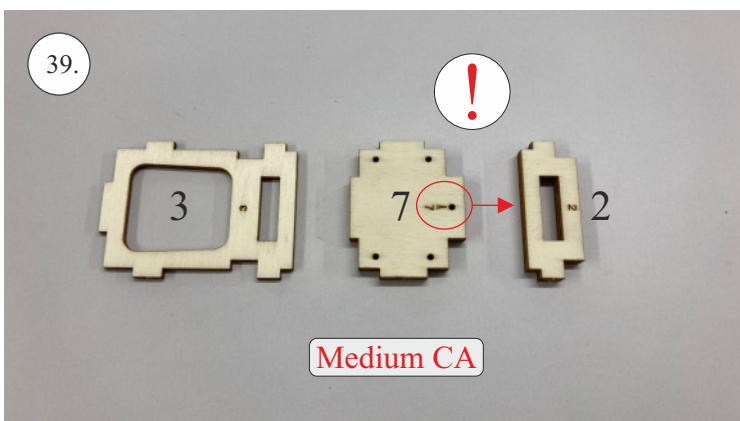
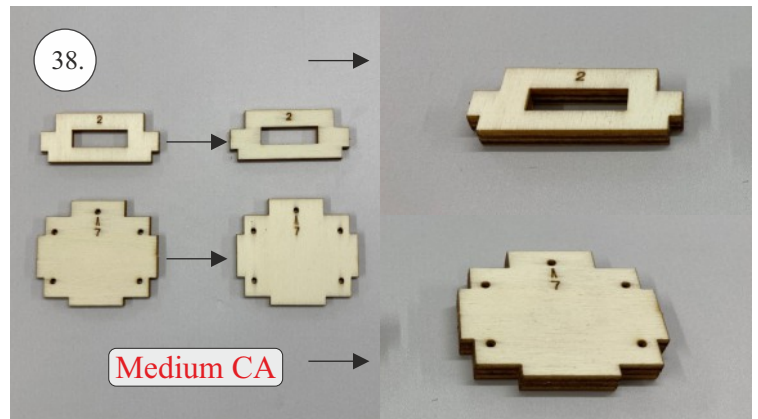
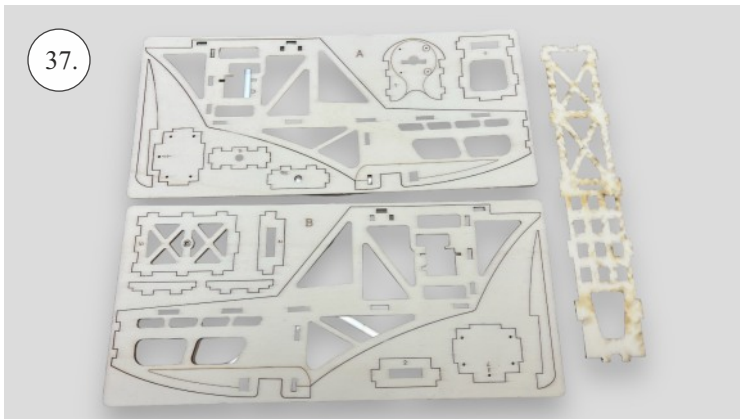
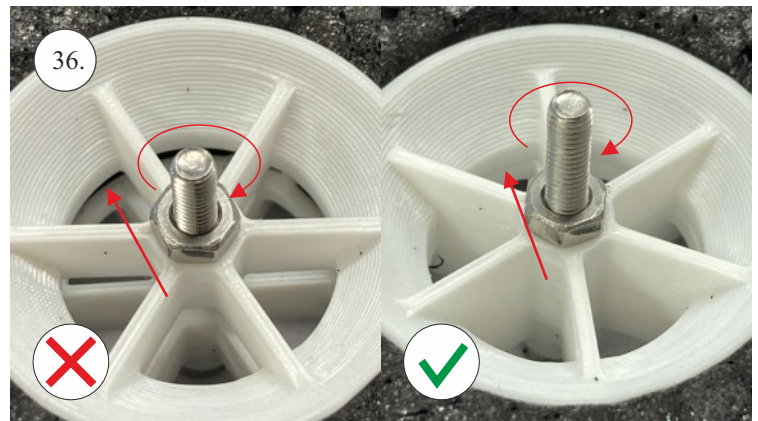
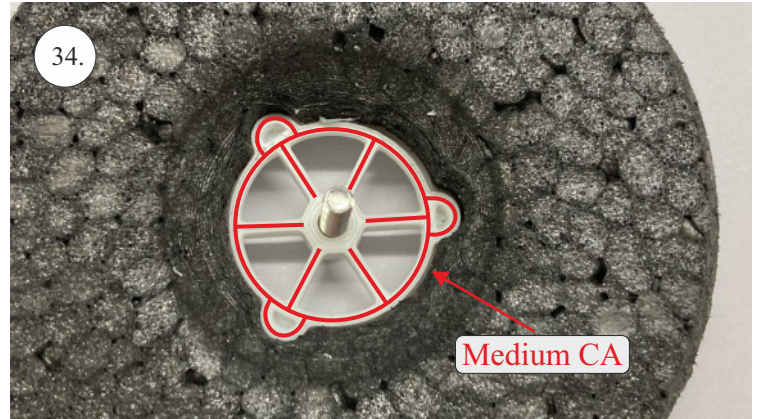
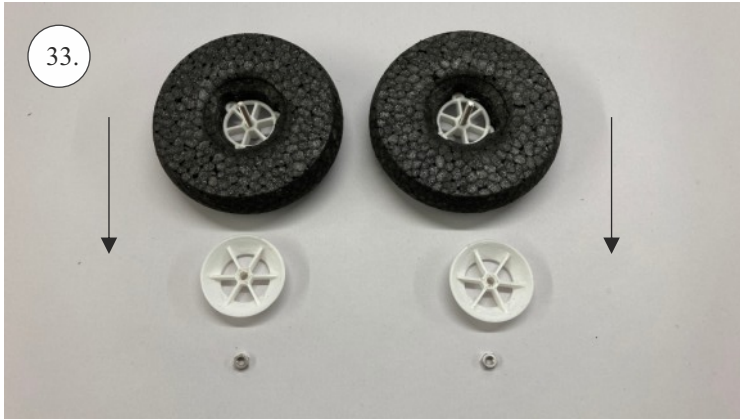

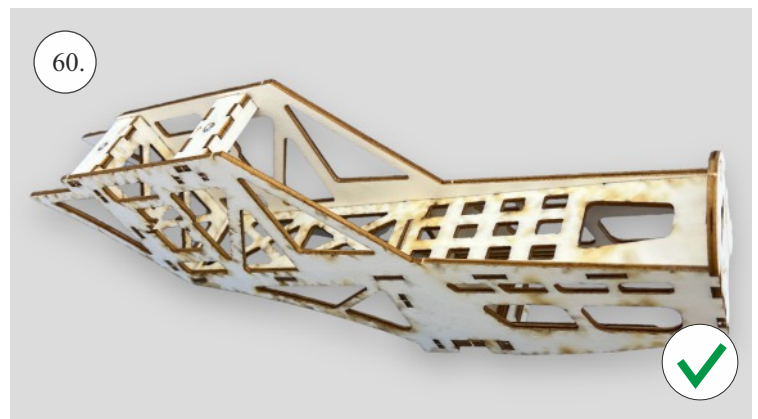
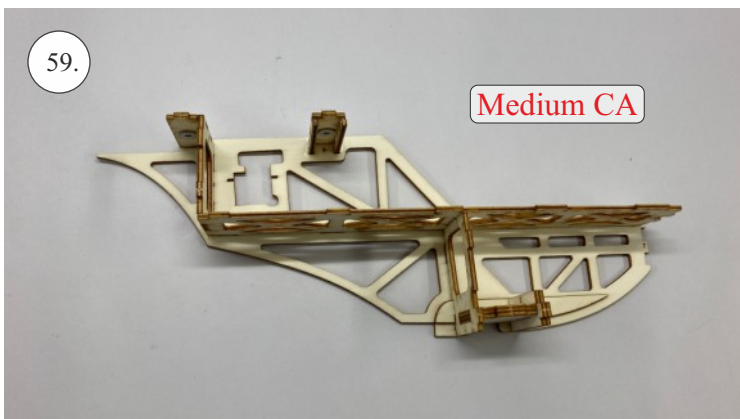
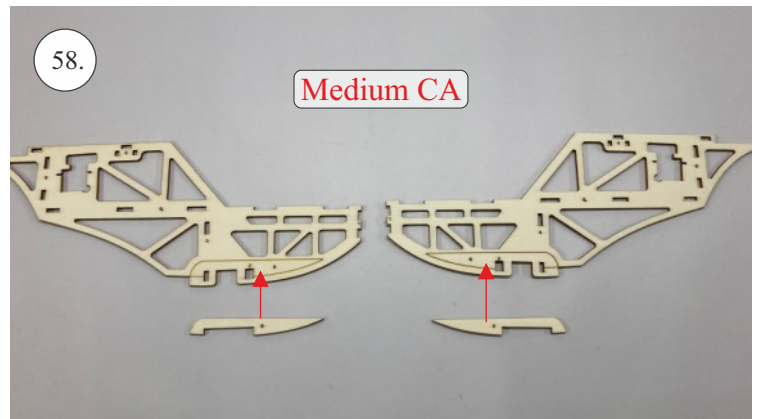
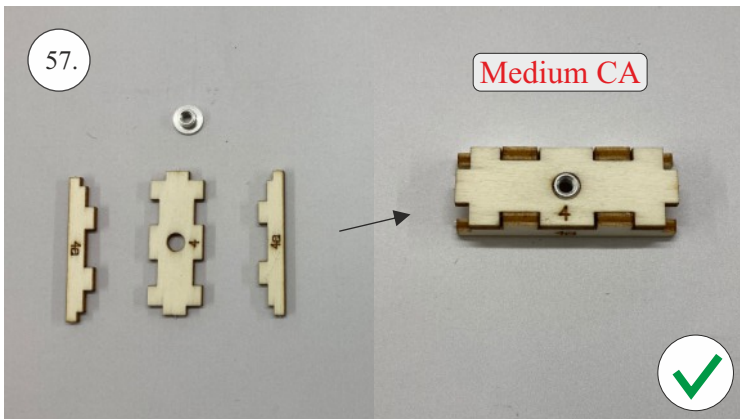
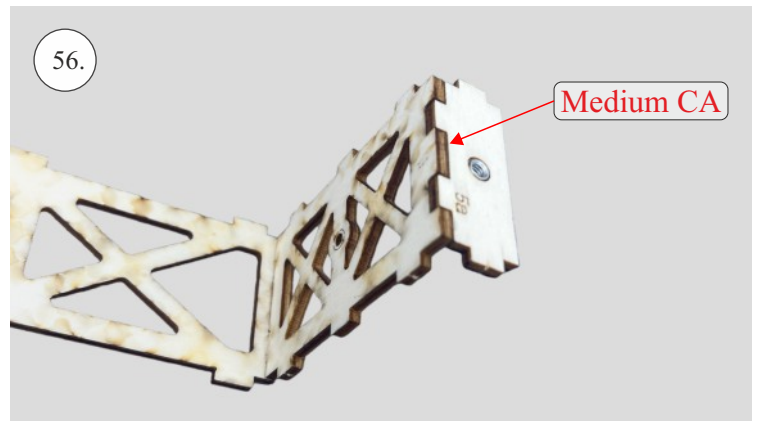
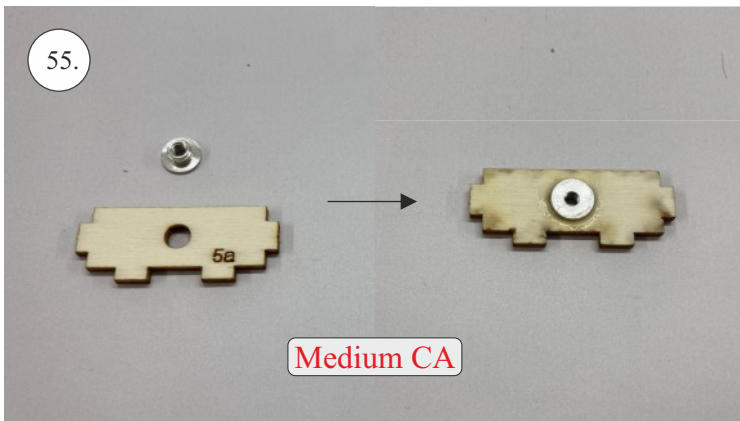
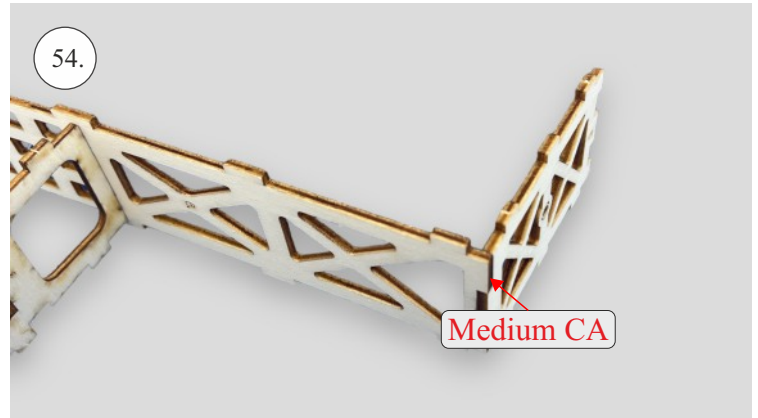
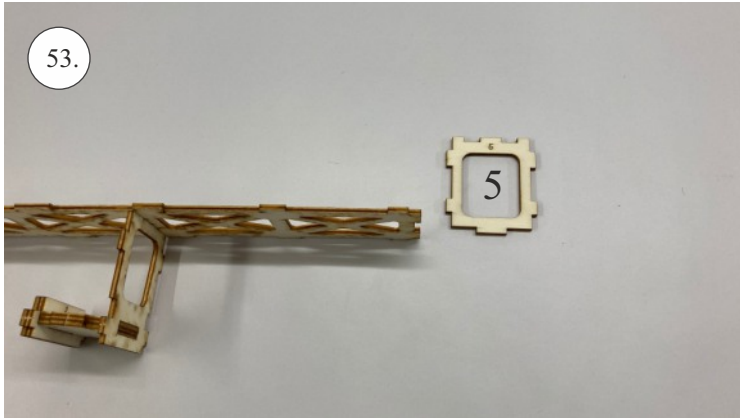
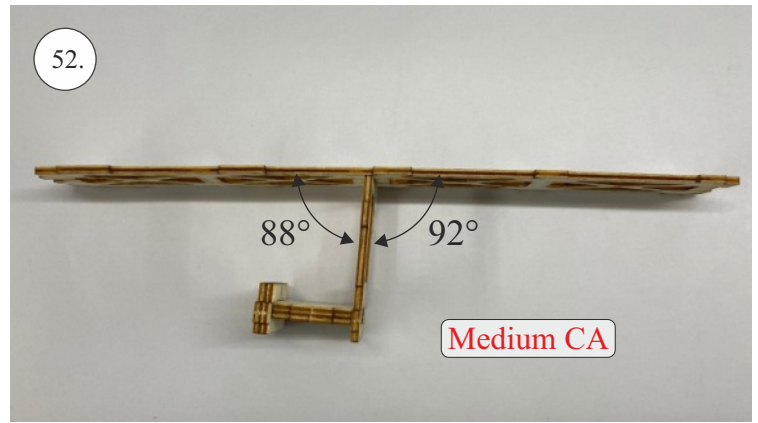
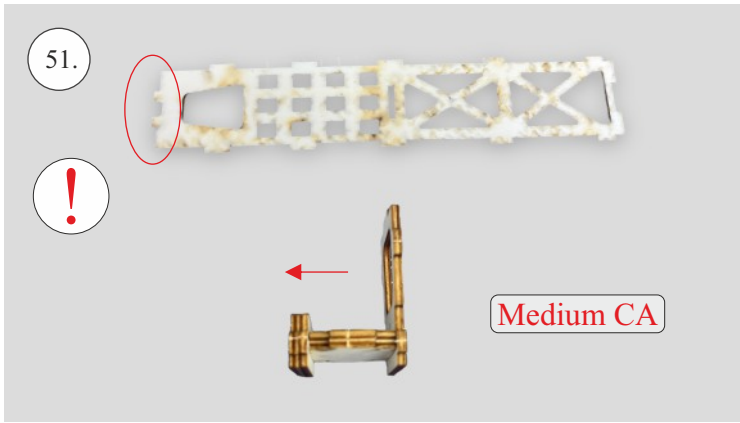

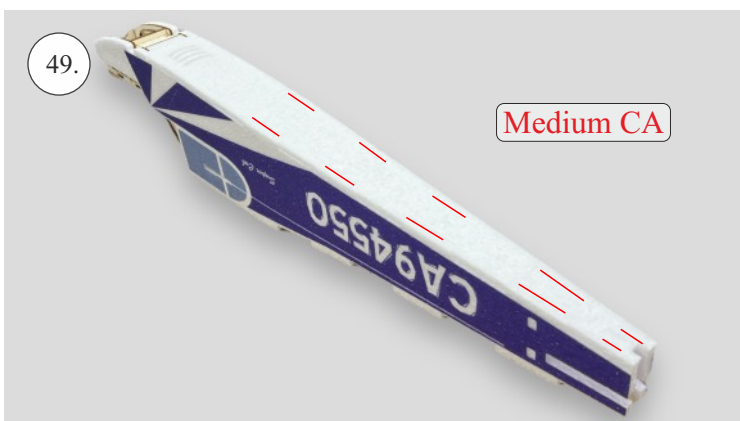
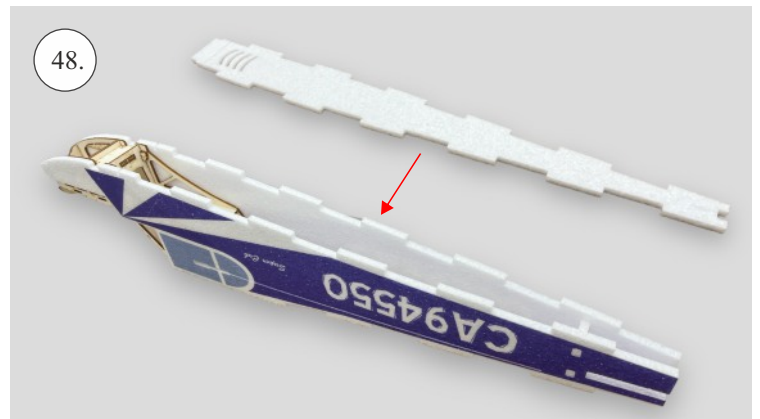
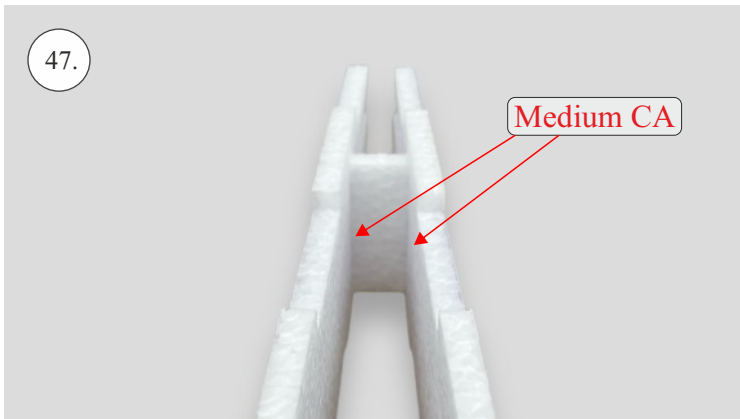
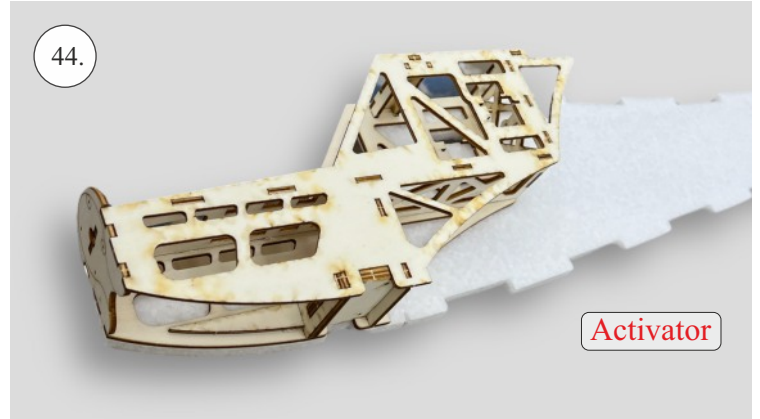
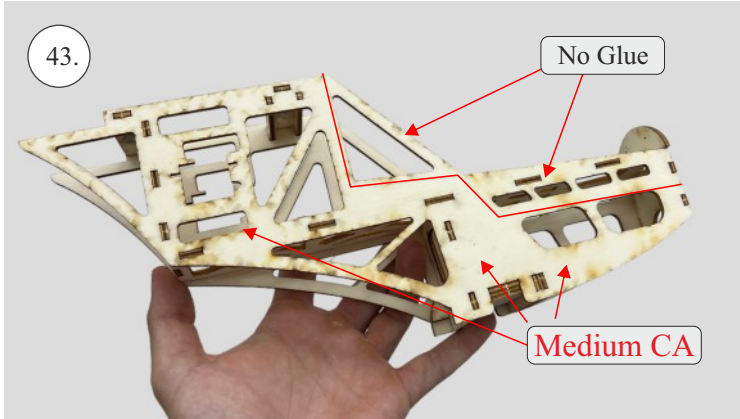
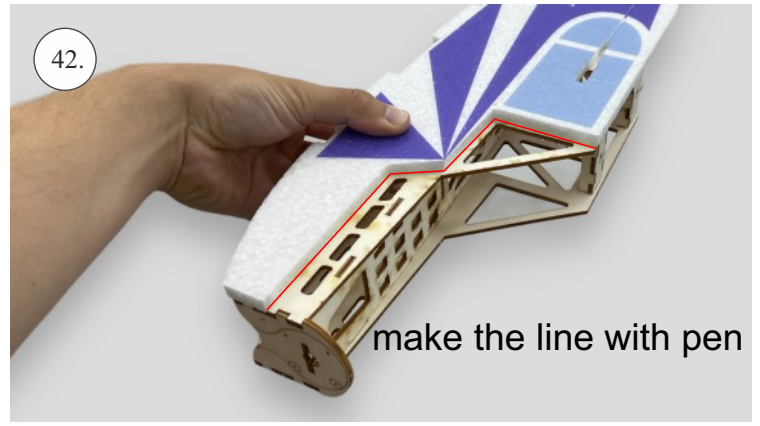
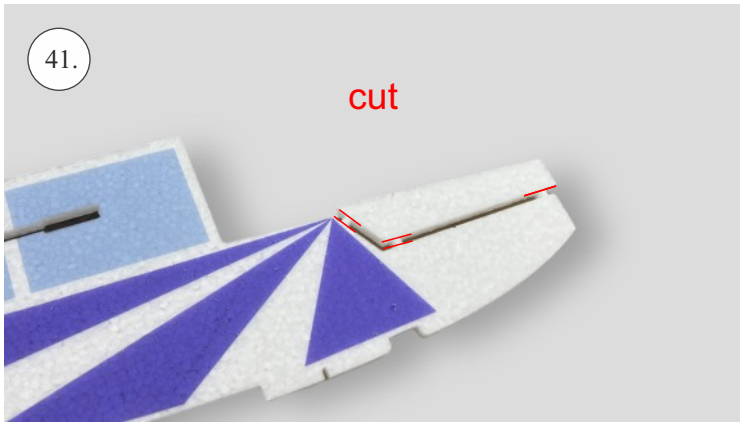

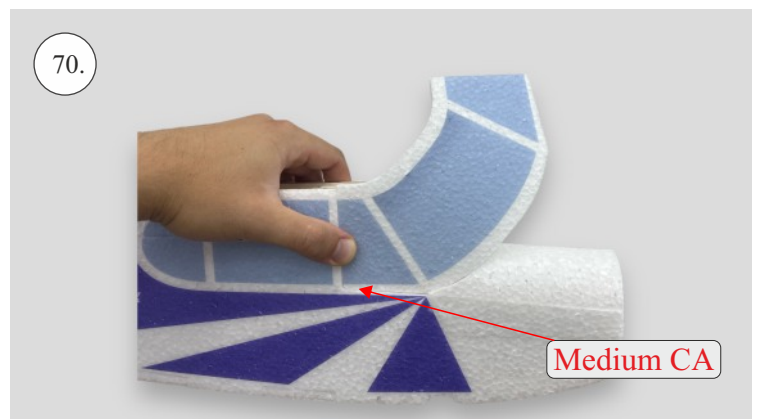
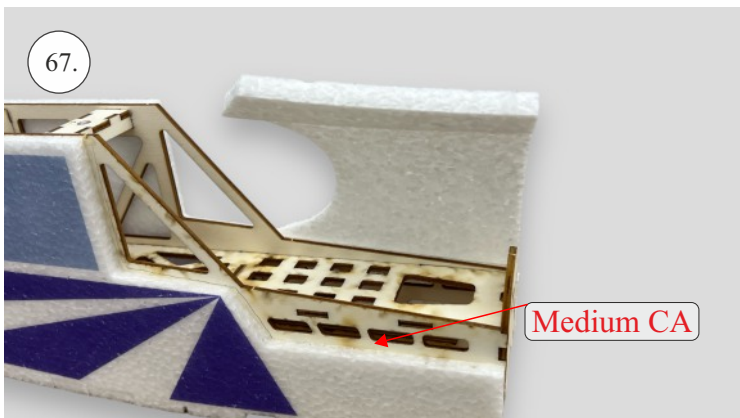
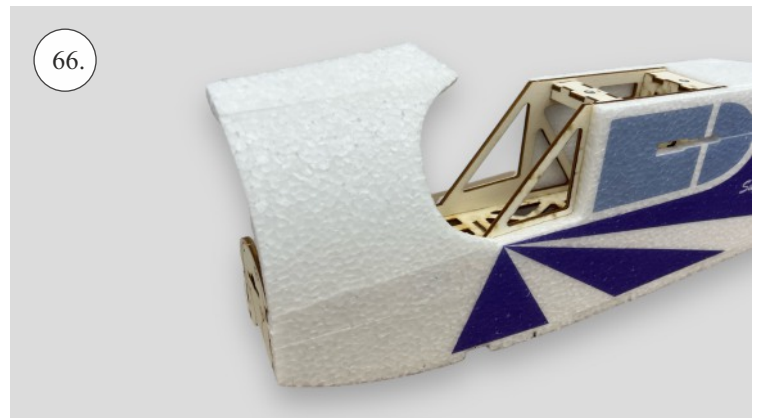
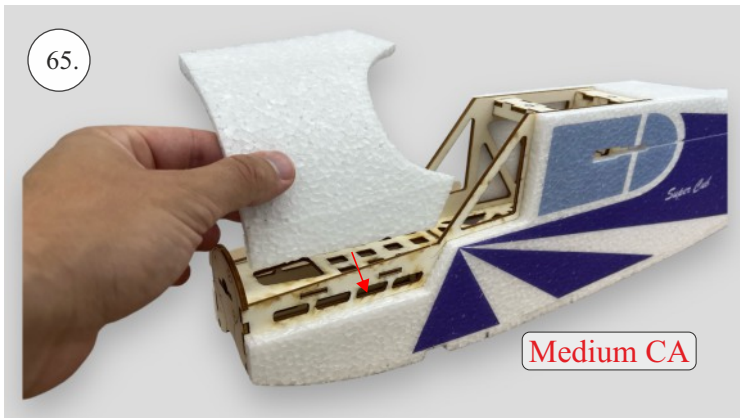
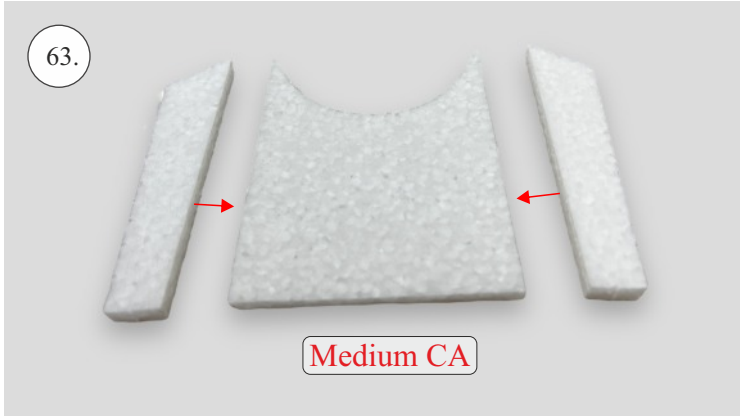

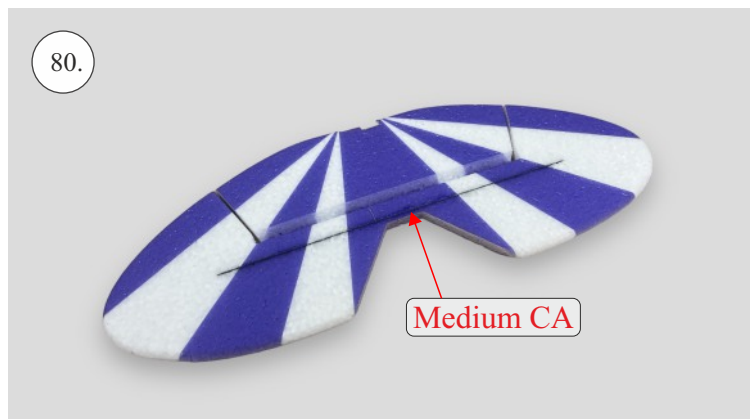
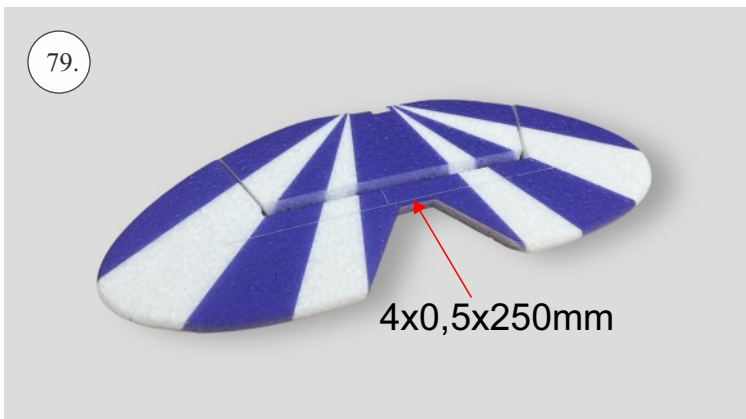
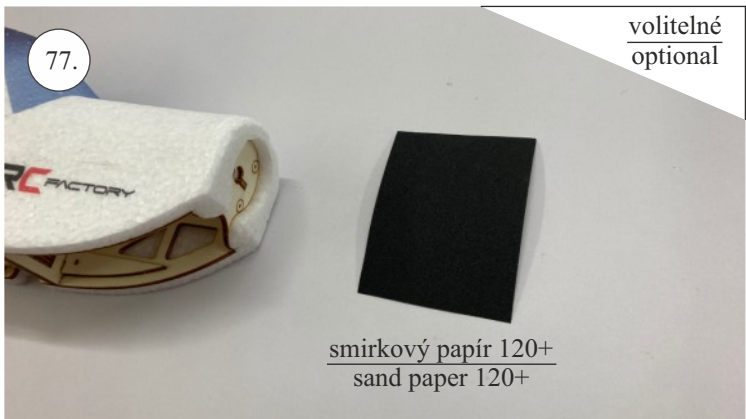
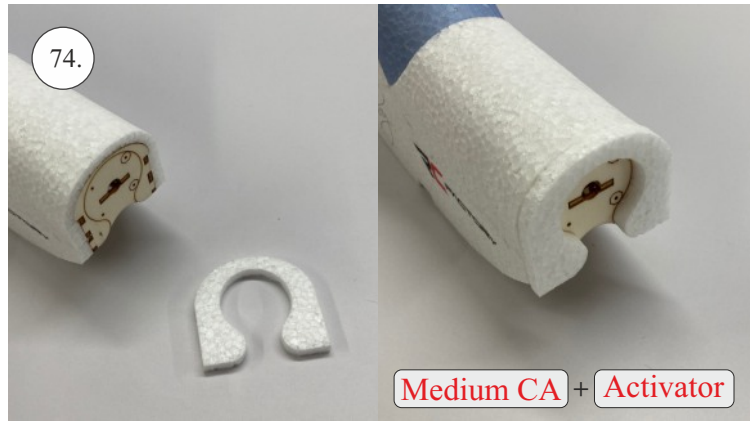
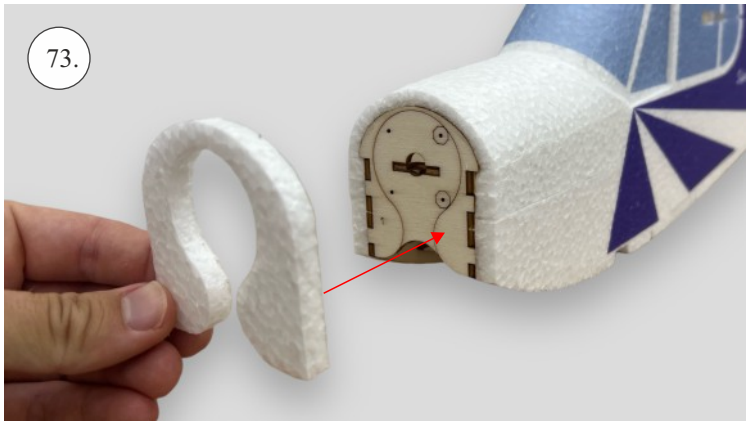
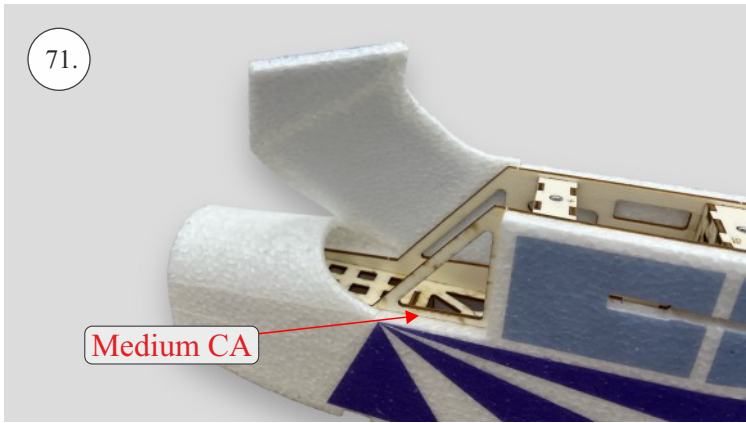

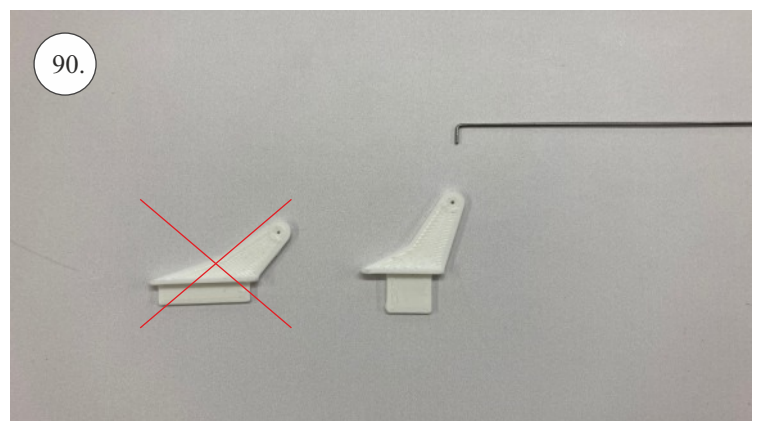
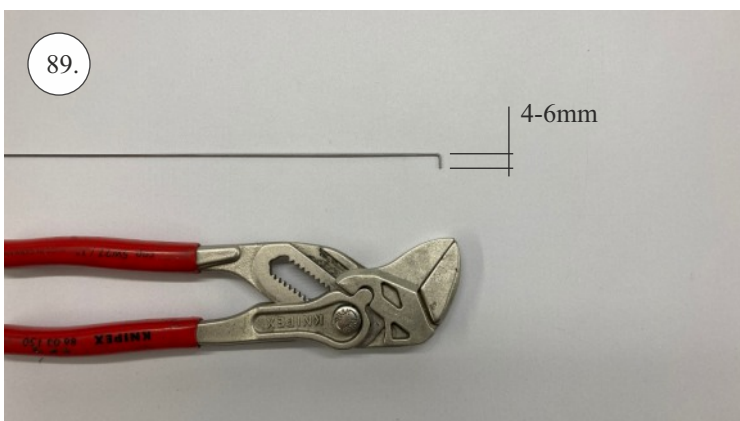
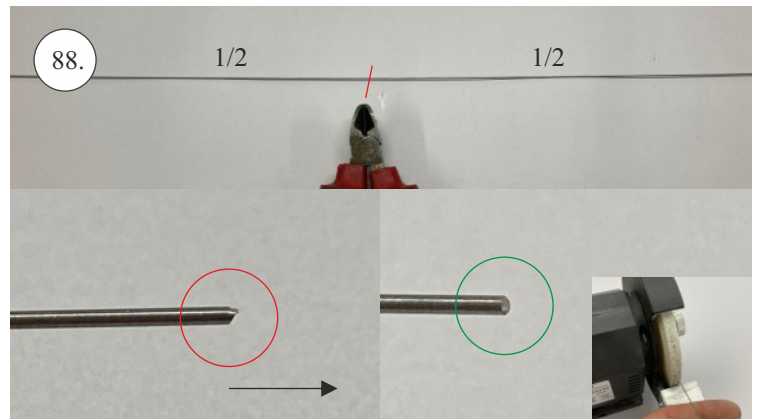
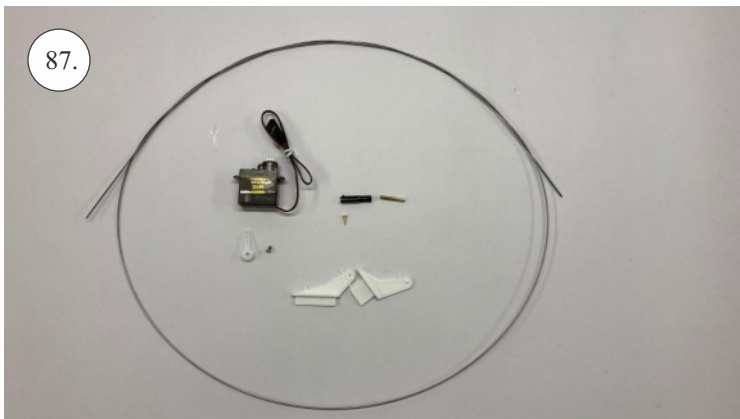
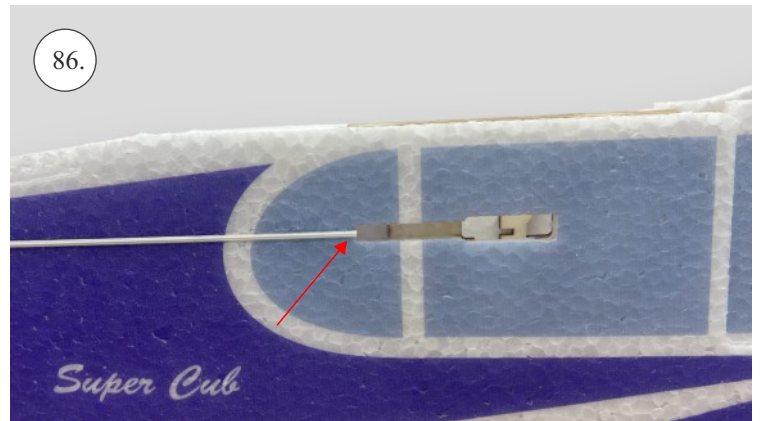
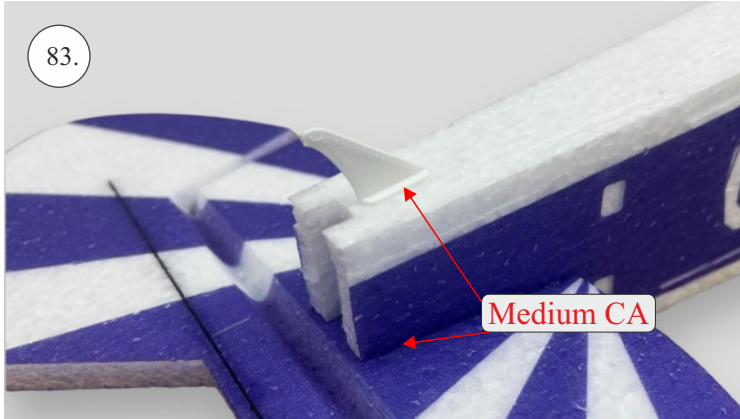
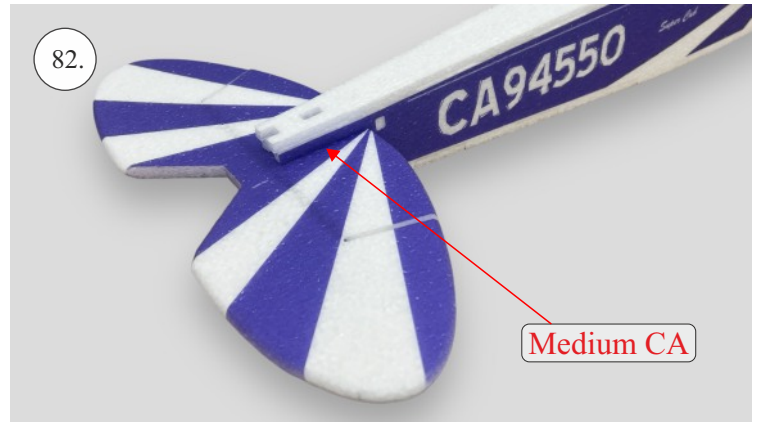
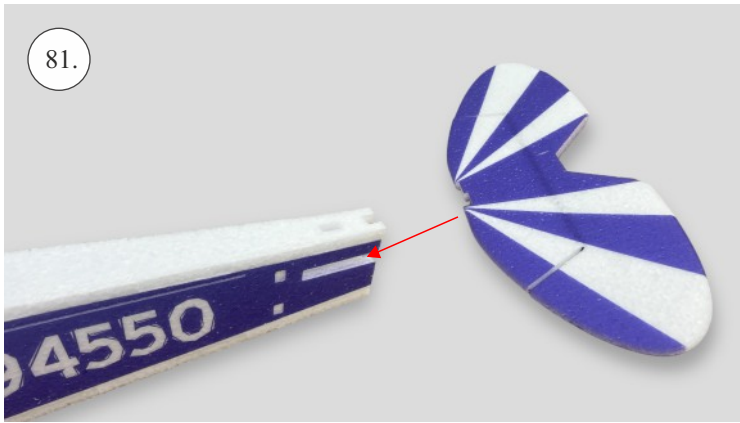

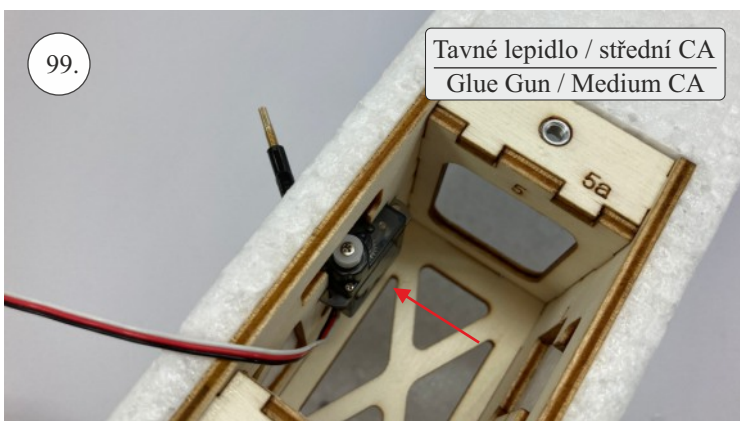
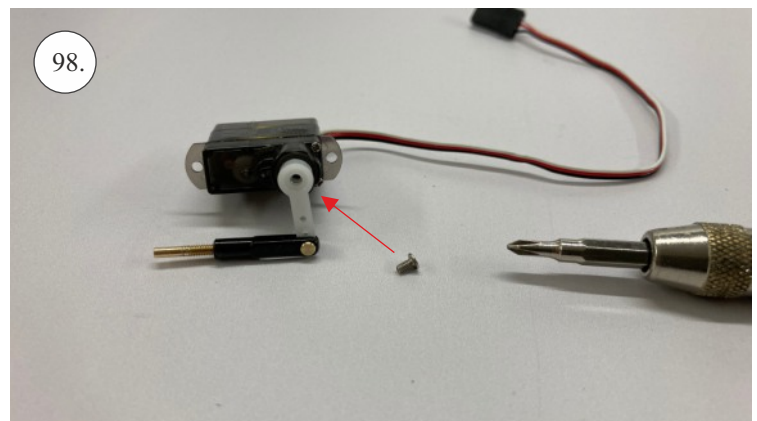
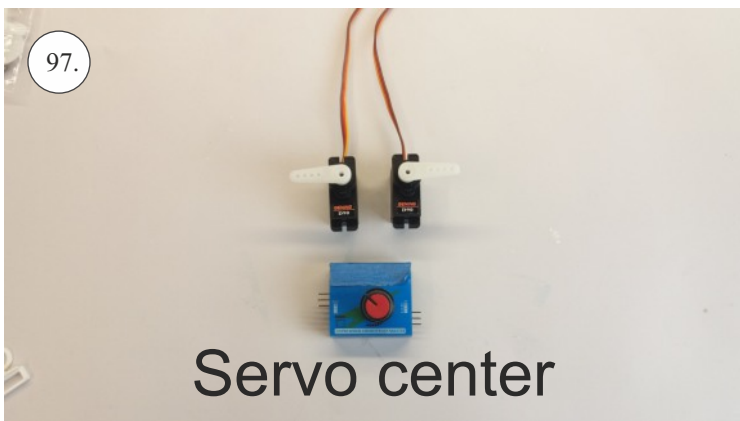
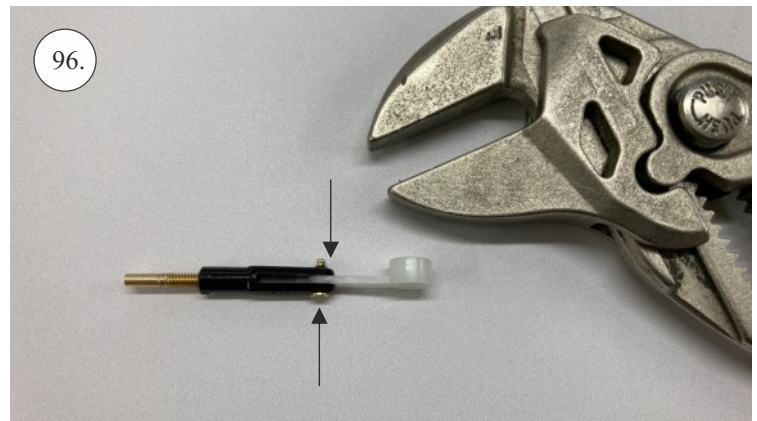
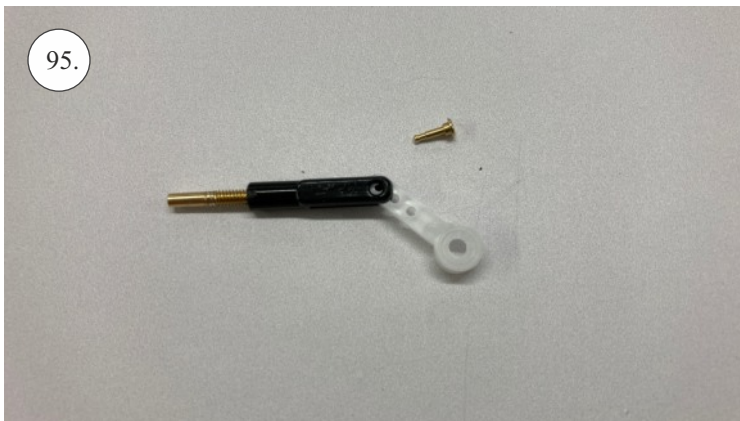
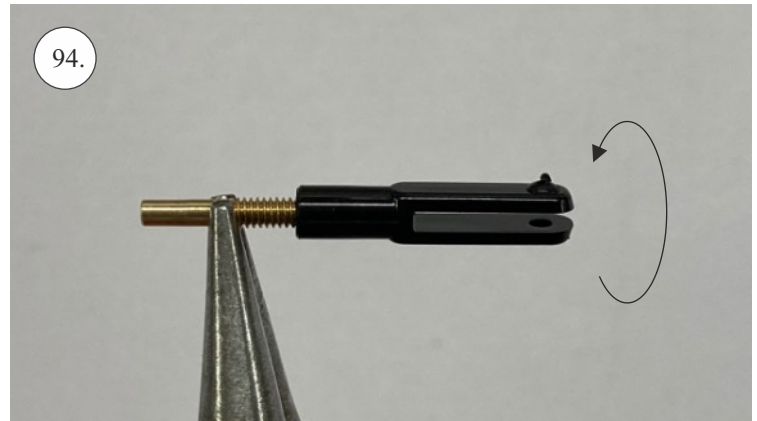
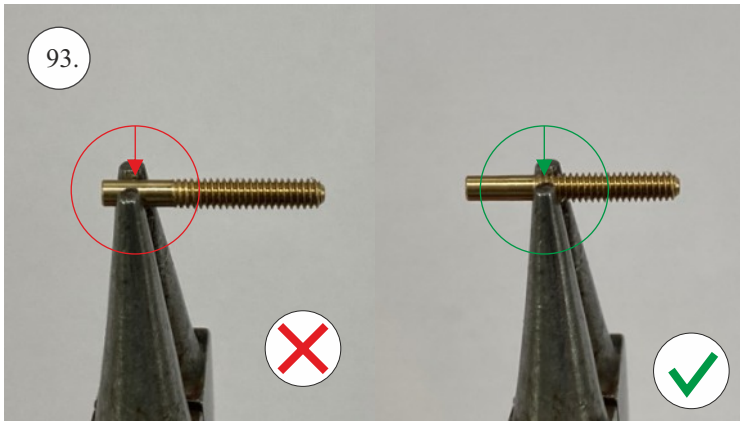
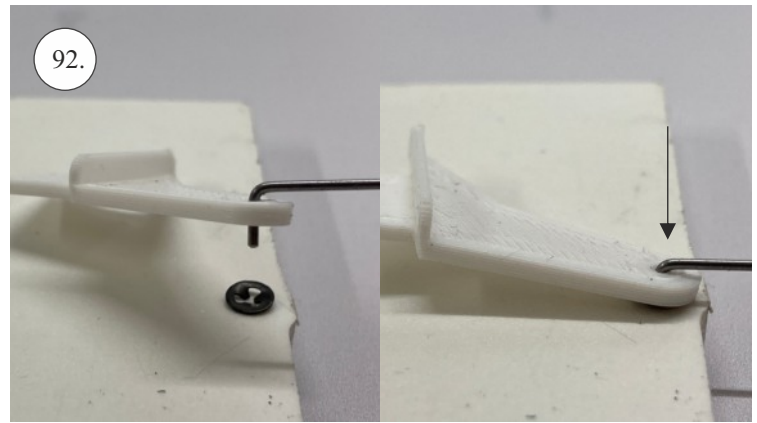
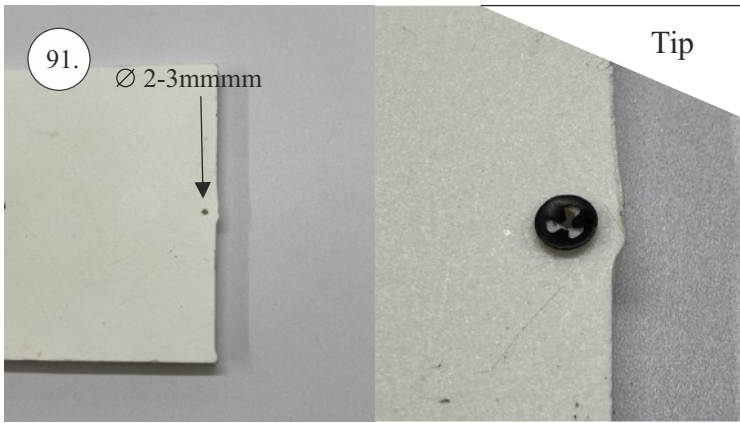

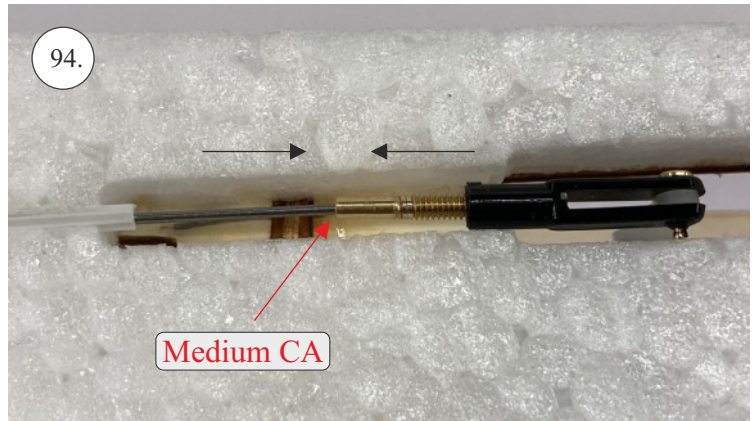
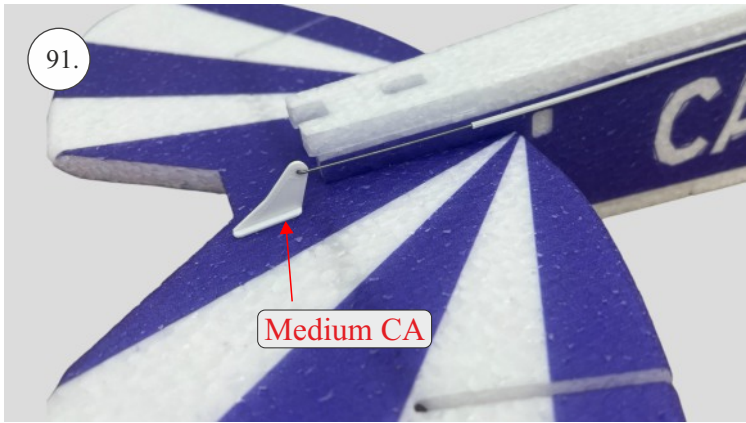

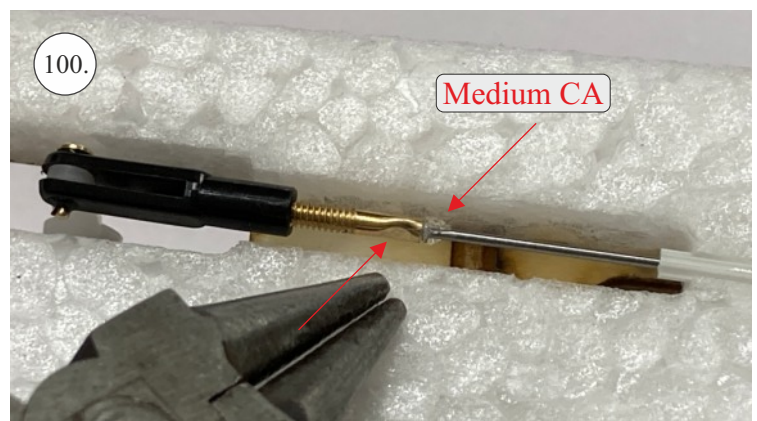
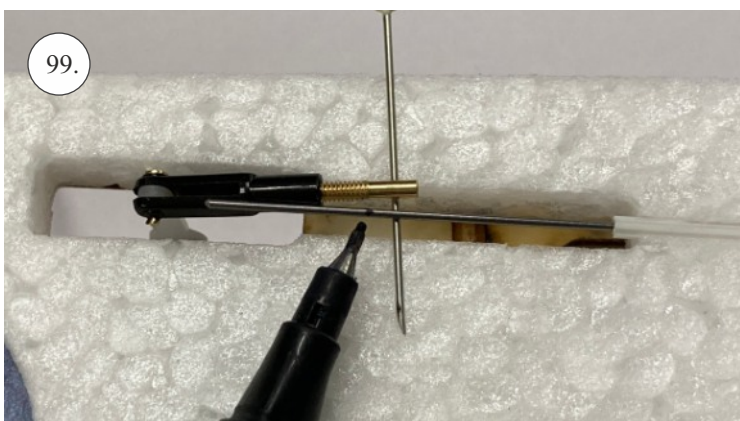
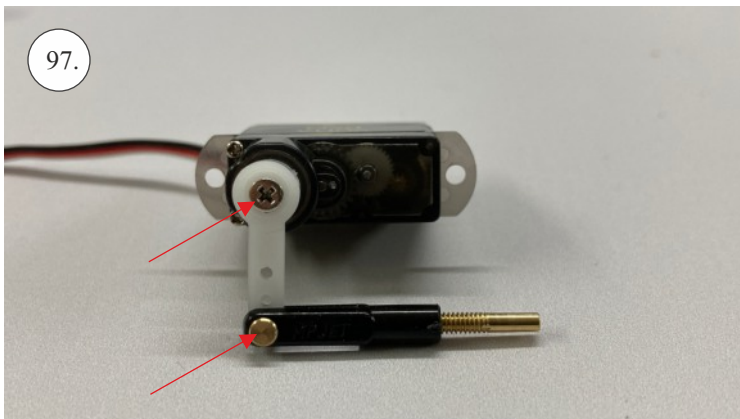
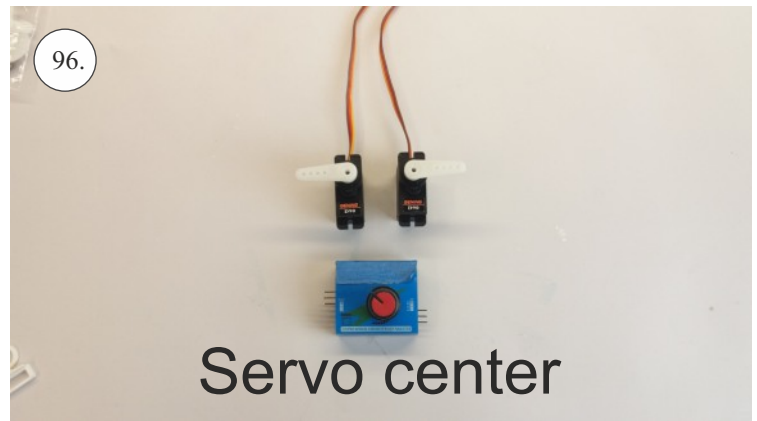
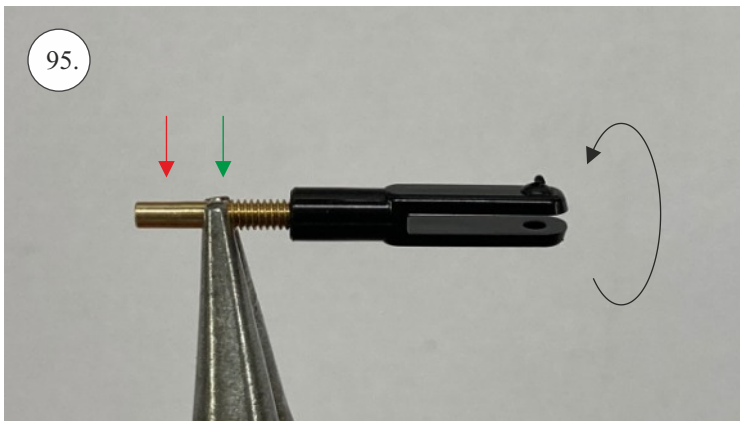
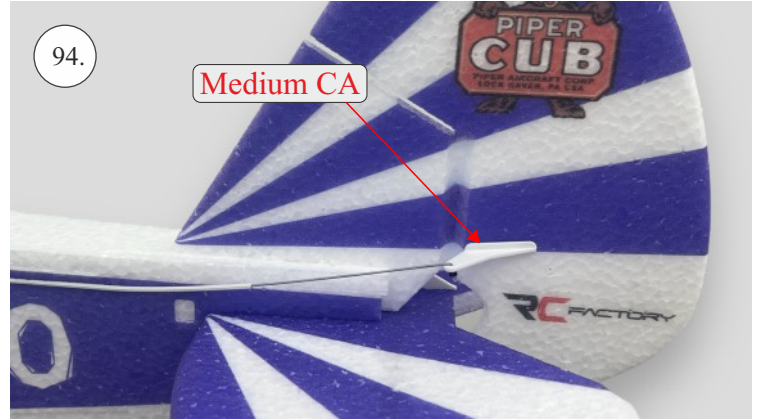
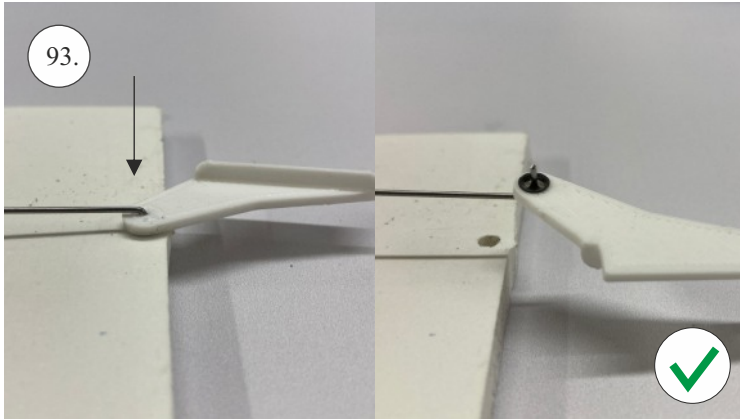
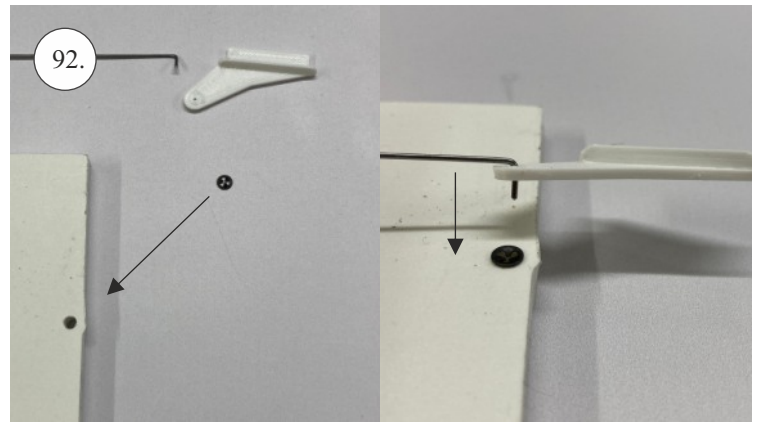
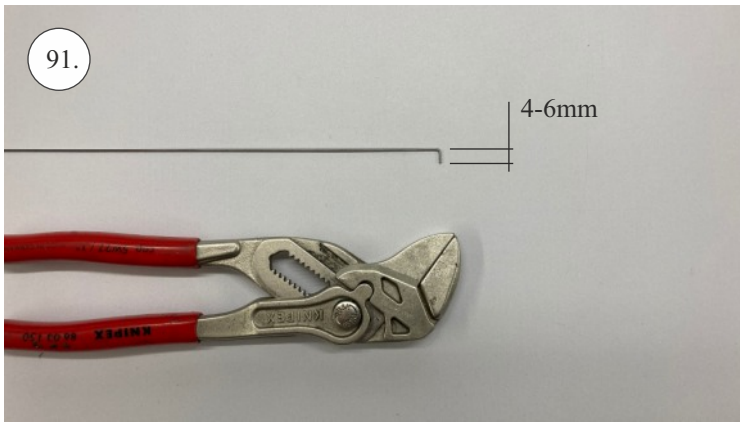

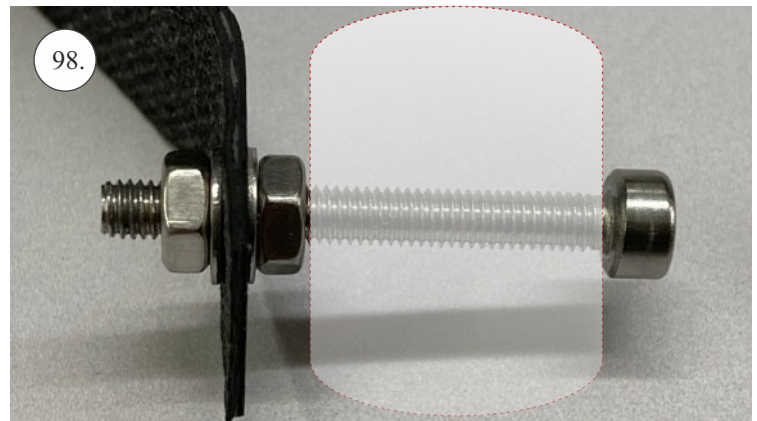
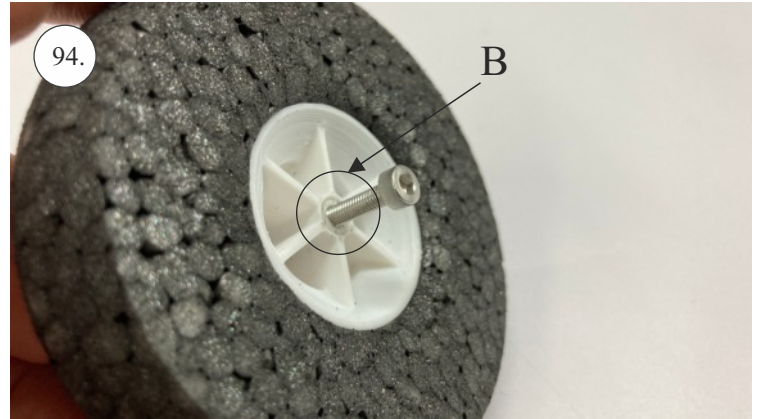
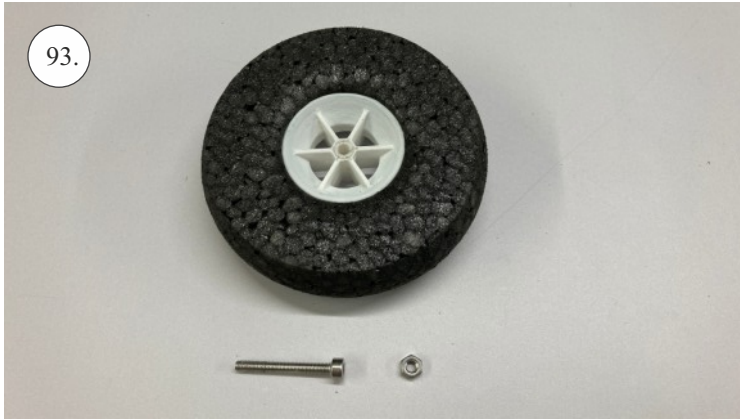
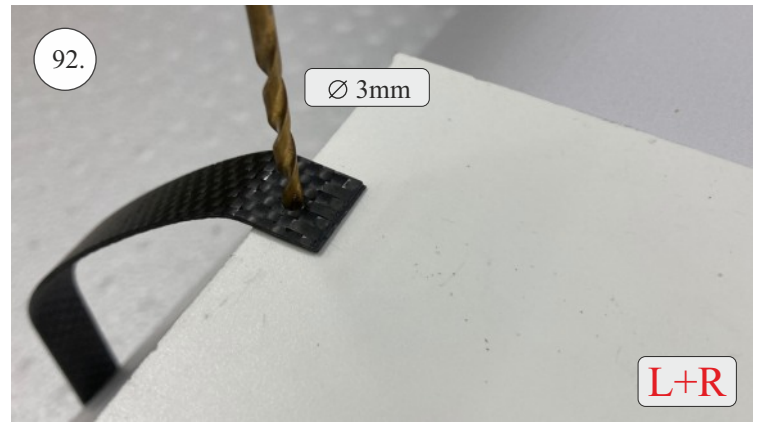

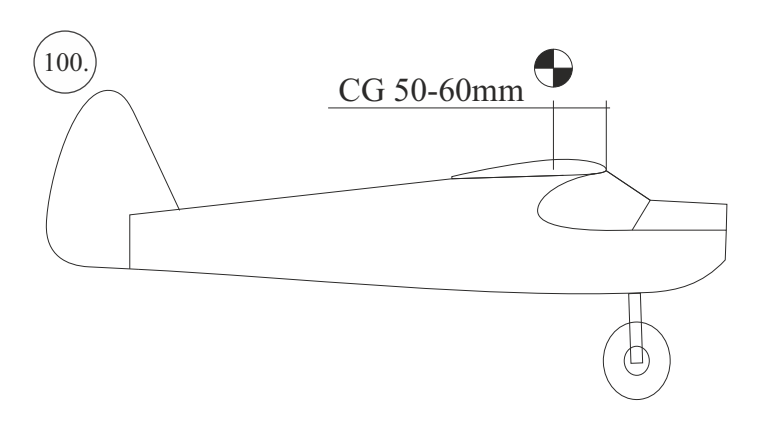
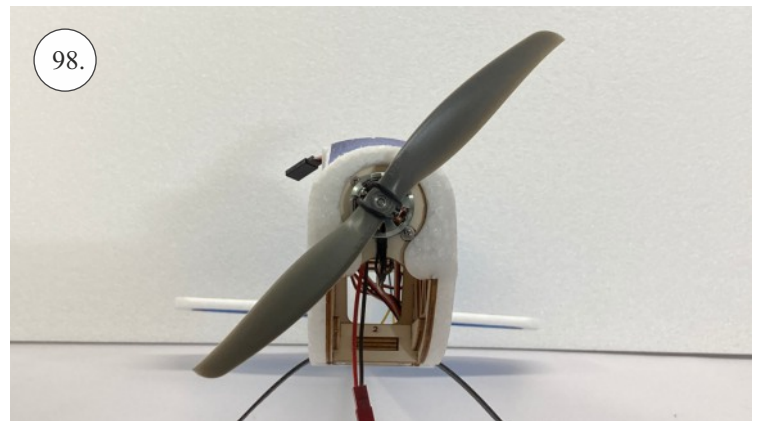
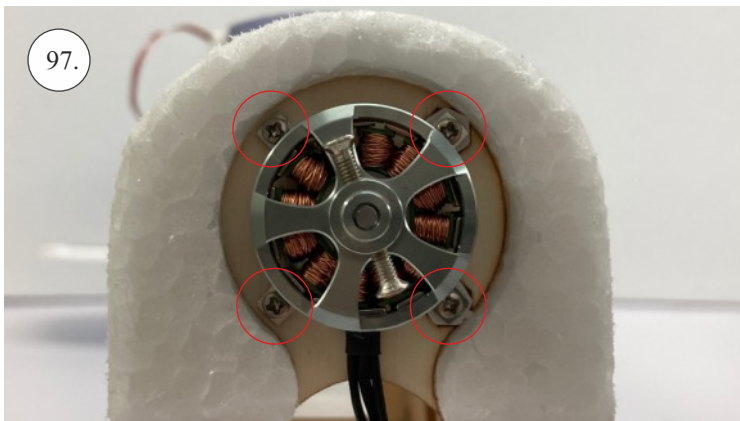
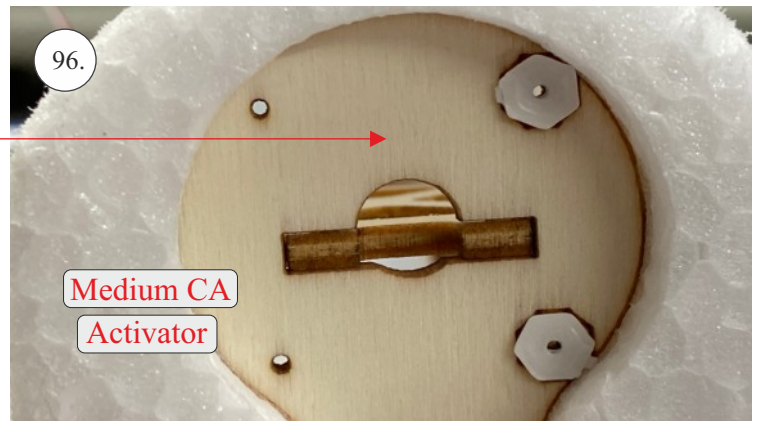
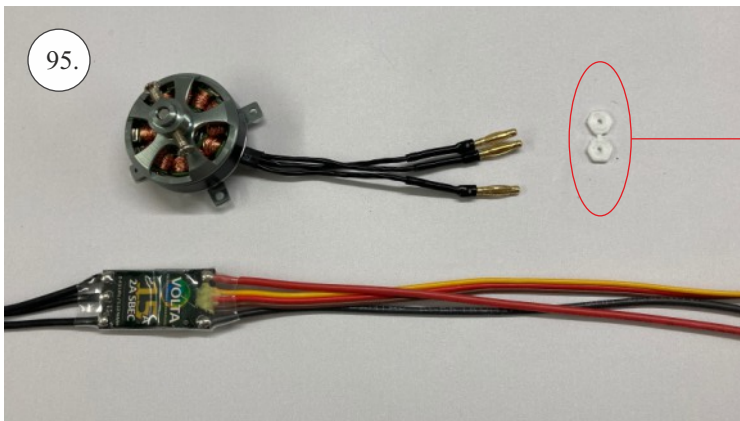
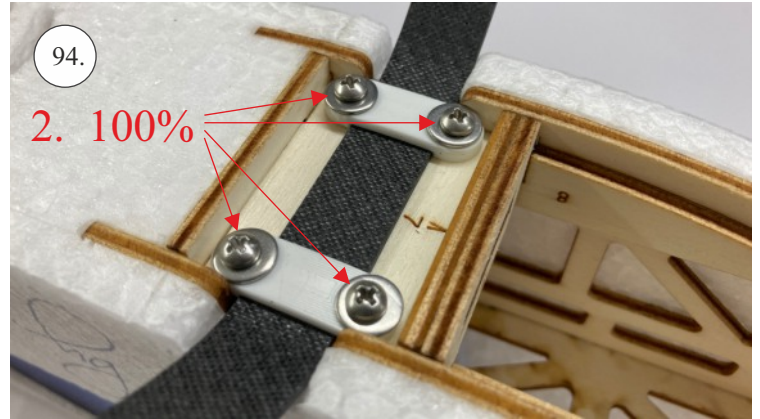
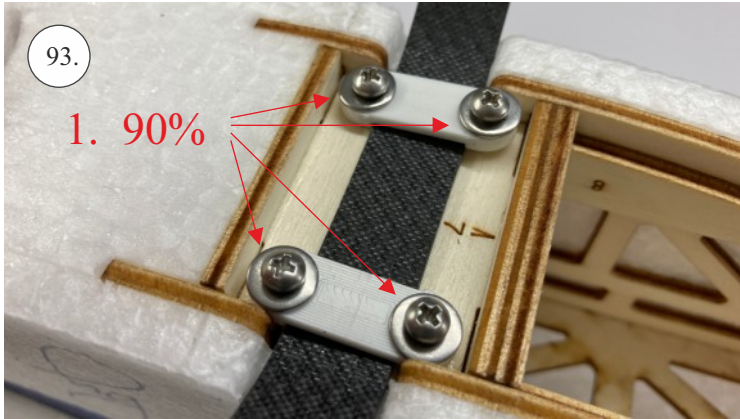
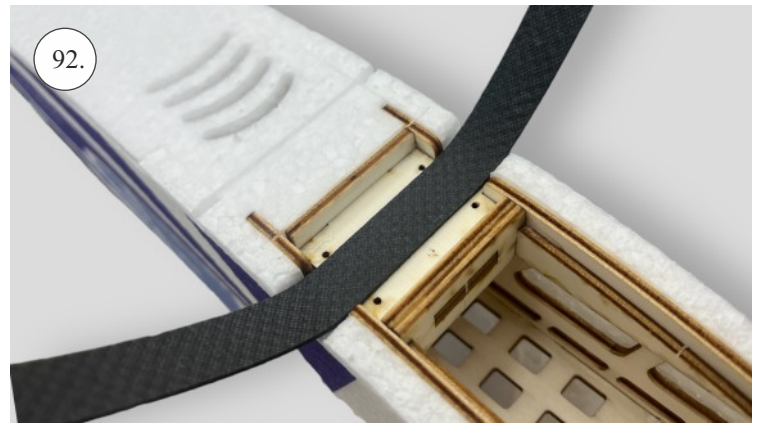
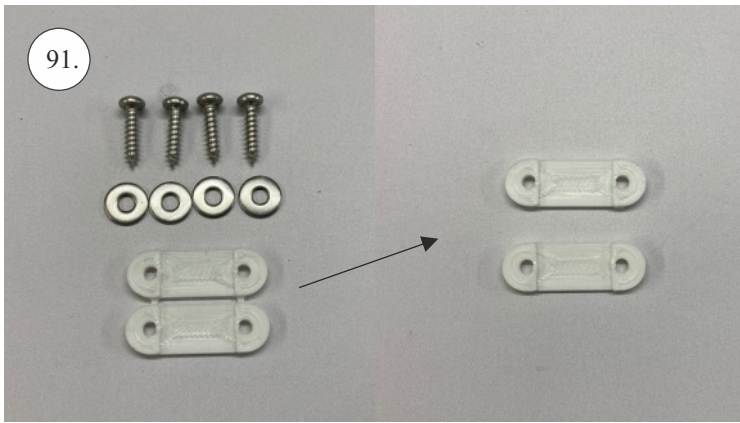

Tuning kits on www.rc-factory.eu



You can upgrade your Piper with flaps and floats!



We wish you many happy flying hours with your Piper SC!

RC Factory team